

可调节型人工晶体 : CrystaLens (C&C Vision)

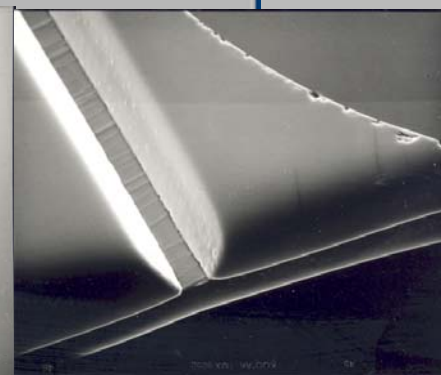

可调节型人工晶体：1CU (HumanOptics)

总直径：
9.7 mm

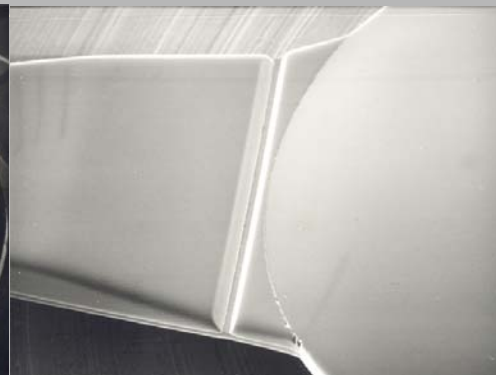
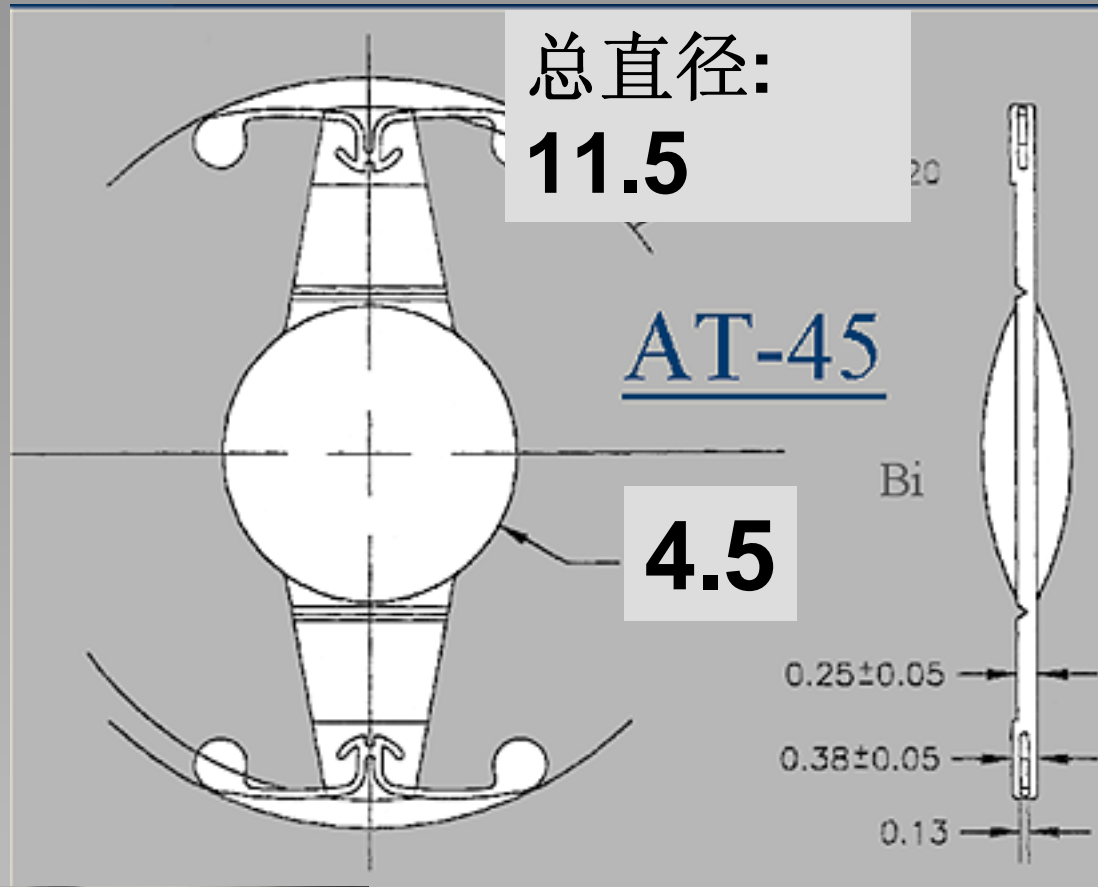
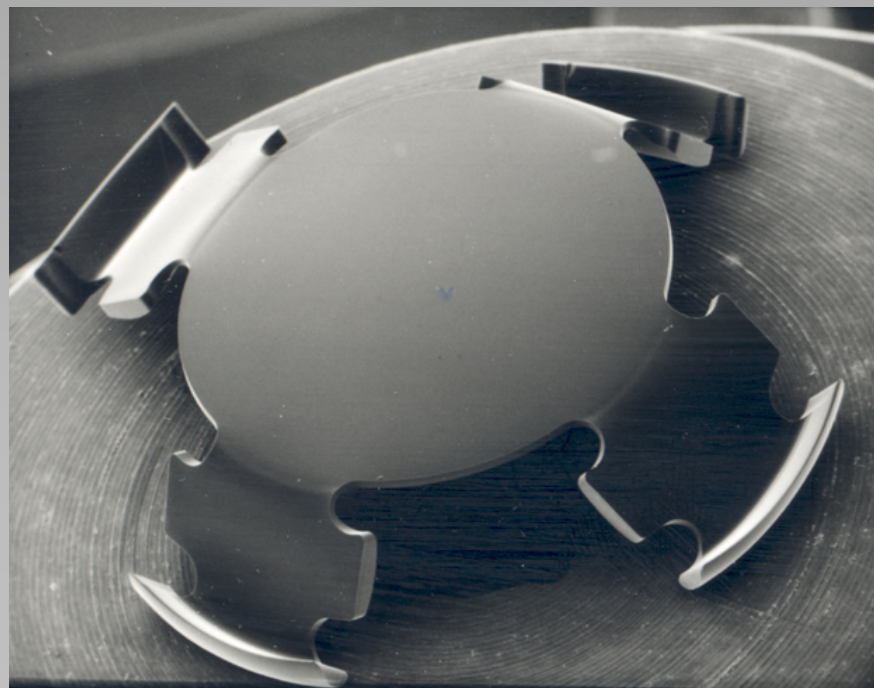
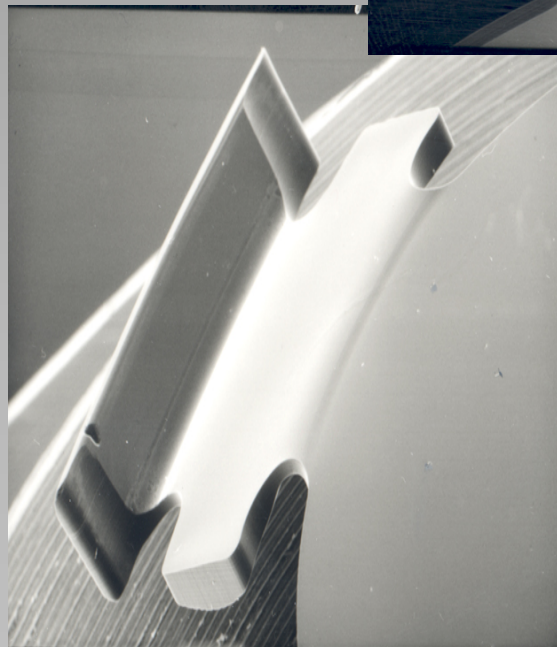
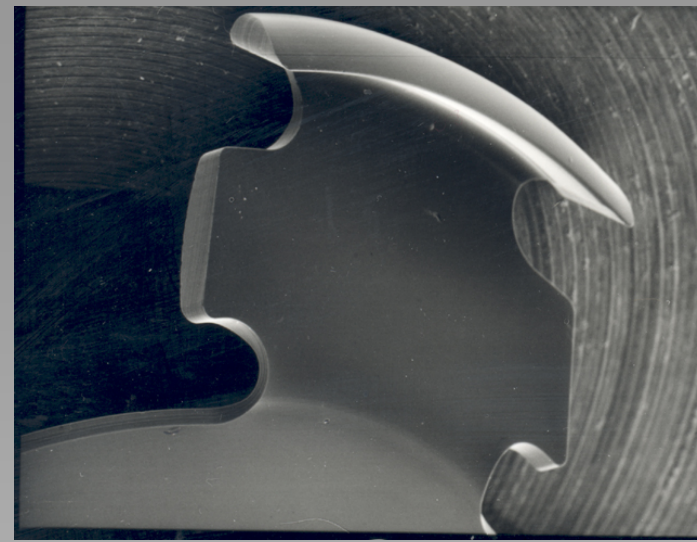
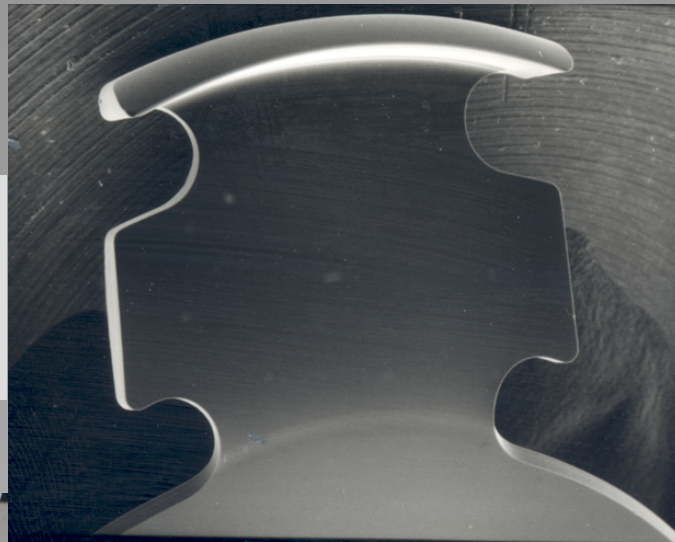

屈光度随时间的变化: 稳定性

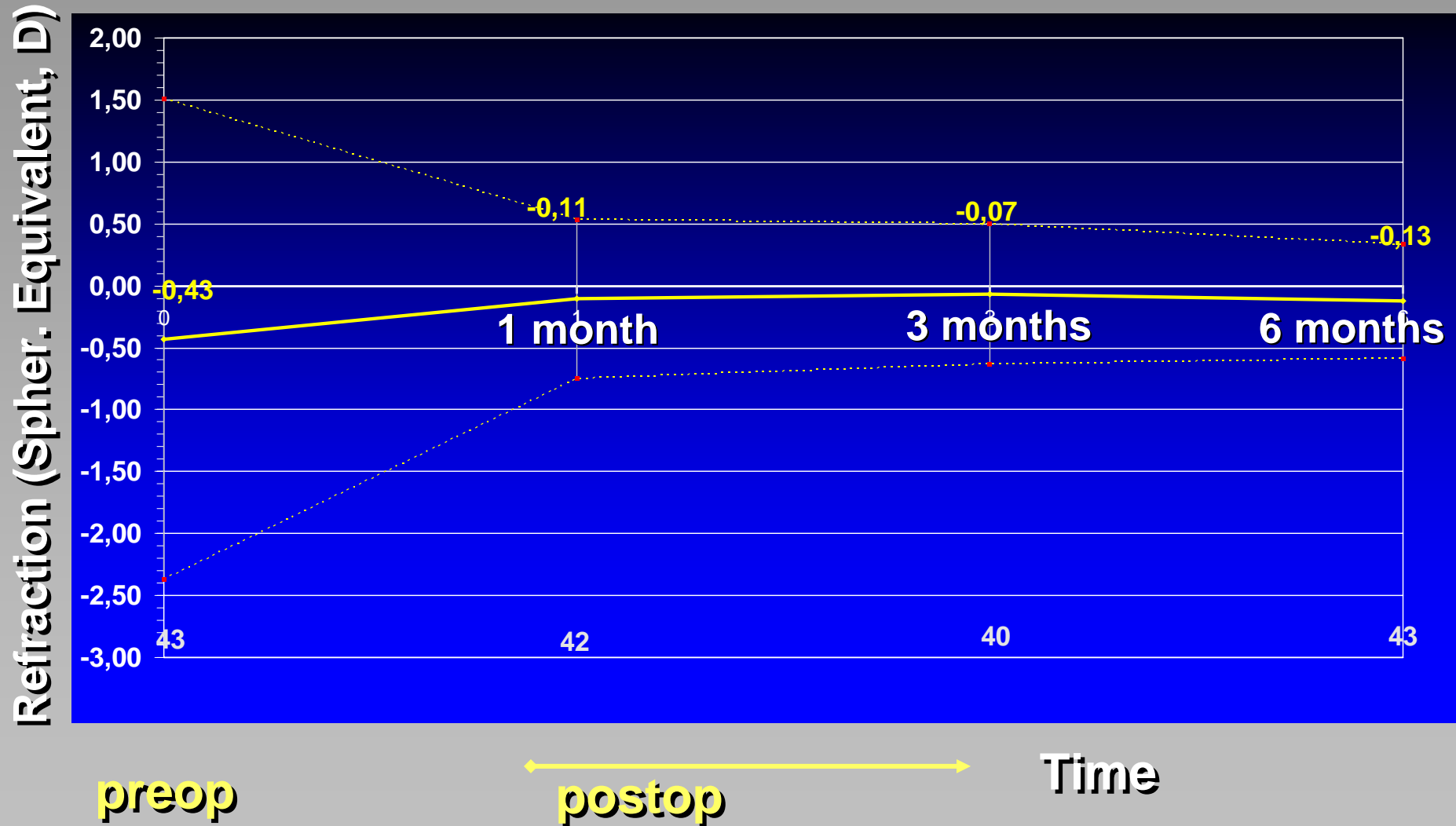

1CU

预期值 vs 实际值: 可预测性 (术后6个月)

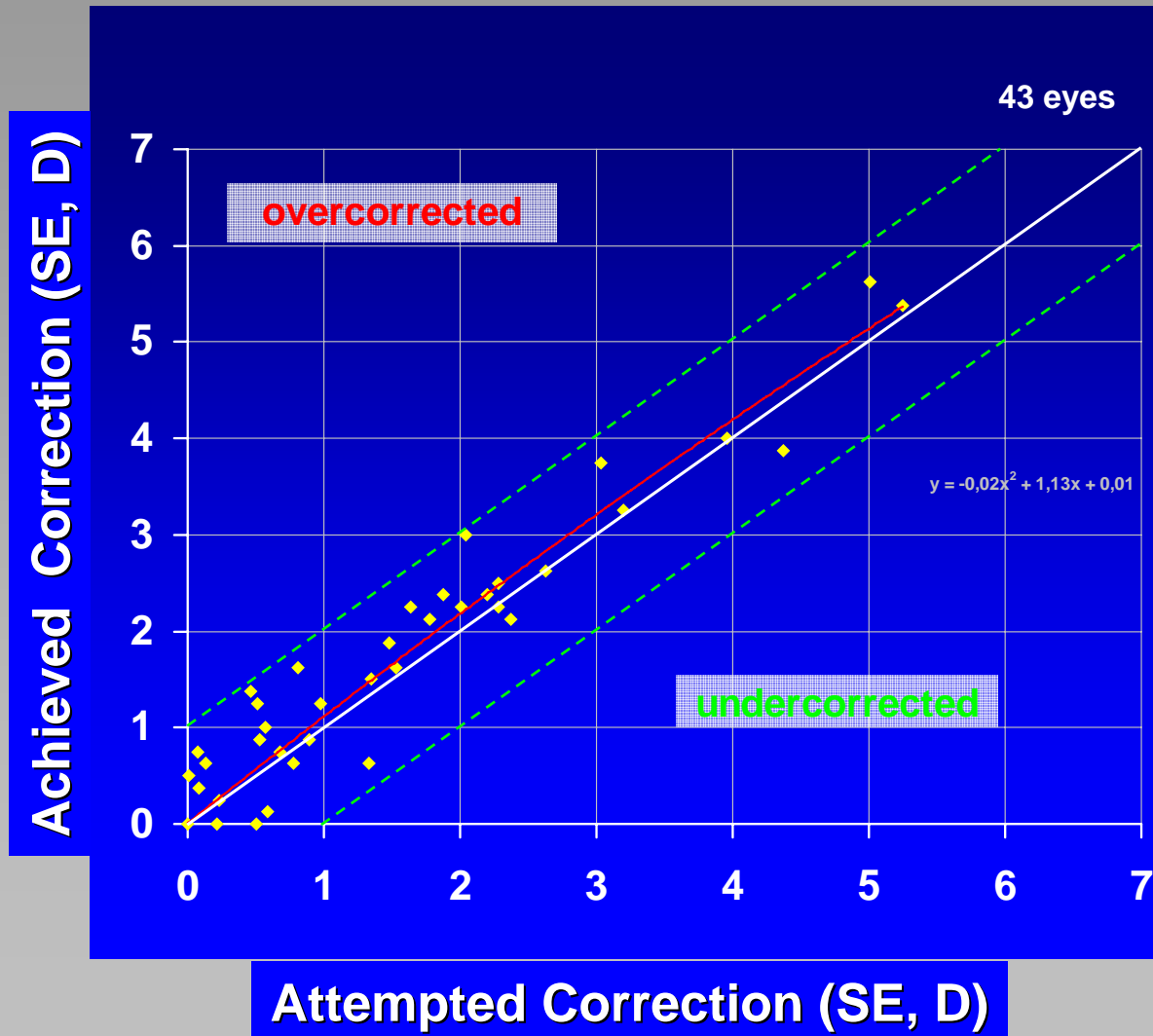

UCVA (百分比): 有效性

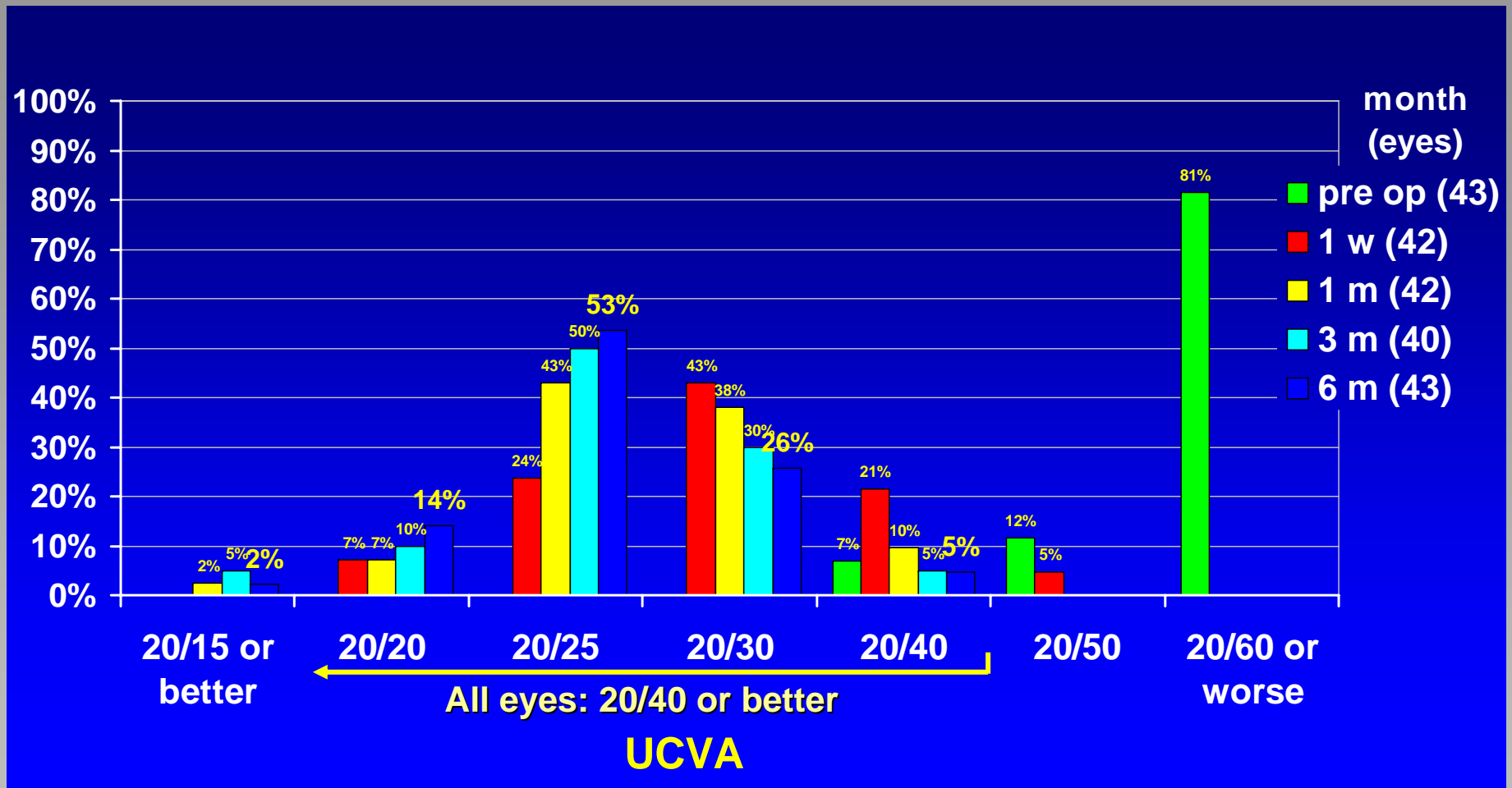

81% (35/43) : 裸眼近视力达到20/30或更好

无并发症 (incl. Nd:YAG 后囊切开) 或副反应.